

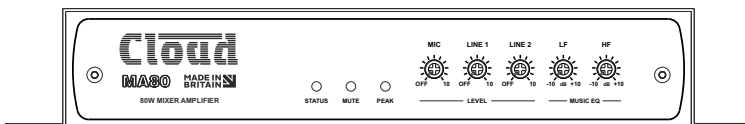

# MA80 Mini Amplifier





 МУЗЦЕНТР  
МУЗЫКАЛЬНОЕ ОБОРУДОВАНИЕ  
<https://muzcentre.ru>

## Installation and User Guide

## WARNING:

To reduce the risk of fire or electric shock, do not expose this appliance to rain or moisture.

	<p>WARNING: SHOCK HAZARD – DO NOT OPEN          AVIS: RISQUE DE CHOC ELECTRIQUE – NE PAS OUVIR</p>
	<p>The lightning flash with the arrowhead symbol within an equilateral triangle, is intended to alert you to the presence of uninsulated dangerous voltages within the product's enclosure that may be of sufficient magnitude to constitute a risk of electric shock.</p>
	<p>The exclamation point within an equilateral triangle is intended to alert the user to the presence of important operating and maintenance (servicing) instructions in the literature accompanying the appliance.</p>

## IMPORTANT SAFETY INSTRUCTIONS

1. Read these Instructions.
2. Keep these Instructions.
3. Heed all Warnings.
4. Follow all Instructions.
5. Do not use this apparatus near water.
6. Clean only with a dry cloth.
7. Do not block any ventilation openings. Install in accordance with the manufacturer's instructions.
8. Do not install near any heat sources such as radiators, heat registers, stoves or other apparatus (including amplifiers) that produce heat.
9. Do not defeat the safety purpose of the polarized or grounding - type plug. A polarized plug has two blades with one wider than the other. A grounding type plug has two blades and a third grounding prong. The wide blade or the third prong are provided for your safety. When the provided plug does not fit into your outlet, consult an electrician for replacement of the obsolete outlet.
10. Protect the power cord from being walked on or pinched particularly at plugs, convenience receptacles, and the point where they exit from the apparatus.
11. Only use attachments/accessories specified by the manufacturer.
12.  Use only with the cart, stand, tripod, bracket or table specified by the manufacturer or sold with the apparatus, when a cart is used, use caution when moving the cart/apparatus combination to avoid injury from tip-over.
13. Unplug this apparatus during lightning storms or when unused for long periods of time.
14. Refer all servicing to qualified service personnel. Servicing is required when the apparatus has been damaged in any way, such as power-supply cord or plug is damaged, liquid has been spilled or objects have fallen into the apparatus, the apparatus has been exposed to rain or moisture, does not operate normally, or has been dropped.



Do not expose the apparatus to dripping or splashing, and ensure that no objects filled with water, such as vases, are placed on the apparatus.

L'appareil ne doit pas être exposé aux écoulements ou aux éclaboussures et aucun objet ne contenant de liquide, tel qu'un vase, ne doit être placé sur l'objet.



The mains plug is used as the disconnect device and it should remain readily accessible during intended use. In order to isolate the apparatus from the mains, the mains plug should be completely removed from the mains outlet socket.

La prise du secteur ne doit pas être obstruée ou doit être facilement accessible pendant son utilisation. Pour être complètement déconnecté de l'alimentation d'entrée, la prise doit être débranchée du secteur.



Terminals marked with the ⚡ symbol may use Class 2 Wiring, but voltages at these terminals may be of sufficient magnitude to constitute a risk of electric shock. The external wiring connected to these terminals requires installation by an instructed person or the use of pre-made leads or cords.



## EU Declaration of Conformity

**DATE OF ISSUE:** 27<sup>th</sup> September 2018

**MANUFACTURER:** Cloud Electronics Limited

**ADDRESS:** 140 Staniforth Rd,  
Sheffield,  
S9 3HF. UK

**PRODUCT NAMES:** MA80EK, MA80NA, MA80AUS  
MA80FTEK, MA80FTNA, MA80FTAUS  
MA80EEK, MA80ENA, MA80EAUS

**PRODUCT TYPE:** Mini Mixer Amplifier

Cloud Electronics Ltd declare under our sole responsibility that the listed products comply with the requirements set out in the Council Directive **2014/35/EU** for electrical equipment used within certain voltage limits or Low Voltage Directive (LVD); and with the requirements of directive **2014/30/EU** for Electromagnetic Compatibility (EMC); and the CE Marking Directive **93/68/EEC & RoHS2 Directive 2011/65/EU**

For the evaluation of the compliance with these directives the following standards were applied:

Directive **2014/35/EU** (electrical equipment designed to be used within certain voltage limits);  
Test Specification(s): **BS EN62368-1:2014**

Directive **2014/30/EU** (electromagnetic compatibility);  
Test Specification(s): **BS EN55035:2017 (Immunity)**  
**BS EN55032:2015 (Emissions)**  
**BS EN61000-3-2:2014 (Harmonics)**

Cloud Electronics Ltd declare that the products produced under its brand name are designed and manufactured as professional audio products and therefore outside of the intended scope of the European Commission Regulations (EC) **1275/2008** of 17<sup>th</sup> Dec 2008 implementing Directive **2005/32/EC** of the European Parliament and of the Council with regards eco-design requirements for STANDBY and OFF mode electric power consumption of electrical and office equipment.

**Place and Date Issued:** Cloud Electronics Limited, 27<sup>th</sup> September 2018.

Simon Curtis,  
Managing Director

REACH Directive; it's expected that our suppliers and business partners be aware of their obligations under REACH. Given those conditions, our current products are exempt from REACH pre-registration and later registration activities. We provide a separate EU Reduction of Hazardous Substances document for our RoHS compliant products.

The WEEE directive (2002/96/EC) places an obligation on all manufacturers and importers, trading in the EU, to take back electronic products at the end of their life. Cloud Electronics Ltd accepts the responsibility to finance the cost of disposing of such products. All our products are marked with the WEEE symbol; this indicates that these products must NOT be disposed of with other waste.

**This document may not be changed or copied without authorisation**



The Cloud MA80 Mini Amplifier has been designed to meet the relevant provisions of the US Environmental Protection Agency's ENERGY STAR® Program.

The ENERGY STAR Program exists to identify products that contribute to the saving of energy and the reduction of harmful emissions, thereby both saving you money and protecting the environment.

ENERGY STAR certification is your assurance that this product is energy efficient. You can verify its inclusion in the ENERGY STAR Program at

<https://www.energystar.gov/productfinder/product/certified-audio-video/results>

# CONTENTS

<b>IMPORTANT SAFETY INSTRUCTIONS</b> .....	<b>3</b>
<b>SAFETY INFORMATION</b> .....	<b>9</b>
Safety Notes regarding Installation .....	9
Conformities .....	9
RoHS and WEEE declaration .....	10
Safety Considerations and Information .....	11
Caution – High Voltage .....	11
Caution - Mains Fuse .....	11
Servicing .....	11
<b>OVERVIEW</b> .....	<b>12</b>
Introduction .....	12
Applicable Models .....	12
MA80 main features .....	13
What's in the Box .....	13
<b>BLOCK DIAGRAM</b> .....	<b>14</b>
<b>FRONT PANEL DESCRIPTION</b> .....	<b>14</b>
<b>REAR PANEL DESCRIPTION</b> .....	<b>16</b>
<b>Installation</b> .....	<b>18</b>
Mechanical .....	18
Ventilation .....	19
Connections and adjustments .....	20
Line inputs .....	20
Sensitivity & Gain Control .....	21
Music Level and EQ control .....	21
Line 1 Priority .....	21
Mic inputs .....	22
Mic gain adjustment .....	23
Mic level control .....	23
Mic EQ .....	23
Microphone priority .....	23
Speaker Output .....	23
Auxiliary Output .....	24
Remote Control .....	26
Connecting an RL-1 Series remote control plate .....	26

Control of music level via external DC.....	27
Music Mute Input.....	27
Auto Power Down.....	28
Loudspeaker EQ cards.....	28
Installation Instructions.....	28
<b>Appendix.....</b>	<b>29</b>
PCB layout diagram.....	29
Table of internal jumpers and default settings.....	30
Summary of rear panel DIP switch functions.....	31
Troubleshooting – STATUS LED indications.....	32
Fault resolution.....	32
EMC considerations.....	33
Earthing.....	33
Technical specifications.....	34



# SAFETY INFORMATION

## Safety Notes regarding Installation

- Do not expose the unit to water or moisture.
- Do not expose the unit to naked flames.
- Do not block or restrict any air vent.
- Do not operate the unit in ambient temperatures above 35°C.
- Do not touch any part or terminal carrying the hazardous live symbol ⚡ while power is supplied to the unit.
- Do not perform any internal adjustments unless you are qualified to do so and fully understand the hazards associated with mains-operated equipment.
- The unit has no user-serviceable parts. Refer servicing to qualified service personnel.
- If the moulded plug is cut off the AC power lead for any reason, the discarded plug is a potential hazard and should be disposed of in a responsible manner.

## Conformities

This product conforms to the following European EMC Standards:

**BS EN 55035:2017 (Immunity)**

**BS EN 55032:2015 (Emissions)**

**BS EN 61000-3-2:2014 (Harmonics)**



This product has been tested for use in commercial and light industrial environments. If the equipment is used in controlled EMC environments, the urban outdoors, heavy industrial environments or close to railways, transmitters, overhead power lines etc. the performance of the unit may be degraded.

The product conforms to the following European electrical safety standard:

**BS EN 62368-1:2014**

This product is designed to be compliant with the relevant provisions of

**ENERGY STAR® Eligibility Criteria Ver 3.0 for Audio-Video products.**

## RoHS and WEEE declaration

Cloud Electronics Limited manages its business and collaborates with its suppliers to comply with the European Union restriction of the use of certain hazardous substances in electrical and electronic equipment, RoHS Directive (2002/95/EC), that came into force on 1st July 2006, and similar restrictions in other jurisdictions.



The "crossed out wheelee bin" symbol on the product and represented here is there to remind users of the obligation of selective collection of waste. This label is applied to various products to indicate that the product is not to be thrown away as unsorted municipal waste. At the end of life, dispose of this product by returning it to the point of sale or to your local municipal collection point for recycling of electric and electronic devices.

Customer participation is important to minimize the potential effects on the environment and human health that can result from hazardous substances that may be contained in this product.

Please dispose of this product and its packaging in accordance with local and national disposal regulations, including those governing the recovery and recycling of waste electrical and electronic equipment. Contact your local waste administration, waste collection company or dealer.

## Safety Considerations and Information

The MA80 amplifier must be earthed. Ensure that the mains power supply provides an effective earth connection using a three-wire termination.

### Caution – High Voltage

Do not touch any part or terminal carrying the hazardous live symbol while power is applied to the unit. Terminals to which the hazardous live symbol refers require installation by a qualified person.

### Caution - Mains Fuse

The internal PSU contains no user-replaceable fuses. Mains over-current protection is provided by the fuse in the AC mains plug, which should be rated at 5 A.

### Servicing

The unit contains no user serviceable parts. Refer servicing to qualified service personnel. Do not perform servicing unless you are qualified to do so. Disconnect the power cable from the unit before removing the top cover and do not make any internal adjustments with the unit switched on. Only reassemble the unit using either the original bolts/screws, or ones identical to the original parts

## OVERVIEW

### Introduction

The MA80 is a very compact mono amplifier designed for integration into audio and AV systems where de-centralised installation is advantageous. It is intended as an “install-and-forget” component, and is small enough to be fitted into wall or ceiling voids or in any convenient location adjacent to projectors, flat screen displays or loudspeakers. A simple set of controls and configuration options makes it easy to integrate into any audio system. It is highly suitable for use with in-store digital signage, gallery and museum exhibits and fixed or mobile tour guide systems.

The MA80 can deliver 80 W (mono) into a 4 ohm load. It has two unbalanced stereo inputs for line level signals (typically music sources) and a balanced mic input for announcements, etc. Front panel controls are provided for line input levels, music EQ and microphone level. There are also various preset-type controls and configuration DIP switches on the rear panel, and jumpers mounted internally on the main PCB. A Cloud RL Series remote level control plate can be wired to the rear panel RL-1 connector; this connector also allows music volume control by a third-party control system (e.g., Crestron, AMX, etc.) using a DC voltage in the range 0 – 10 V.

### Applicable Models

This Installation Guide describes the installation and operation of the following model only:

- Cloud MA80 80 W mono amplifier for 4 ohm loudspeakers

**NOTE:** Amplifier models MA80FT and MA80E are NOT covered by this Guide, and when installing either of these models, reference should only be made to the Guides specific to them.

## MA80 main features

- Two unbalanced stereo line inputs with individual gain trims
- Electronically-balanced mic input with separate gain control
- 12 V phantom power selectable by internal jumper
- Front panel control of music and mic levels
- HF & LF EQ adjustments for music sources
- Rear panel HF & LF EQ for mic input
- Selectable MIC-over-LINE priority
- Selectable LINE 1-over-LINE 2 priority
- 80 W power amplifier
- Electronically-balanced auxiliary output, source selectable pre- or post-EQ
- Remote music volume control port: compatible with Cloud RL Series plates
- Music Mute control input (N/O or N/C) for interfacing to an emergency system
- Selectable 65 Hz high-pass filter for use with 100/70/25 V line systems (via external transformer)
- Optional EQ cards available to suit various popular installation loudspeakers
- Automatic power-down function (user-selectable)
- Less than 1 W power consumption in sleep mode
- Convection cooled – silent in operation.
- Power requirements: 100 to 240 V AC, 50 to 60 Hz

### Available Options:

- RL Series remote level control plates
- EQ cards to match various popular installed-sound loudspeakers
- 20 mm Flexible Conduit Adaptor Kit (Warepart CA947034) for permanent installations: replaces IEC receptacle

## What's in the Box

Please check the shipping carton for damage before opening. If there is damage, please contact your Cloud agent and the shippers.

The packing carton should contain the following items:

- MA80 amplifier
- IEC mains lead (AC cord) with moulded plug appropriate to the territory
- Set of mating plug-in screw-terminal connectors
- Set of four self-adhesive polyurethane feet
- This manual

# BLOCK DIAGRAM

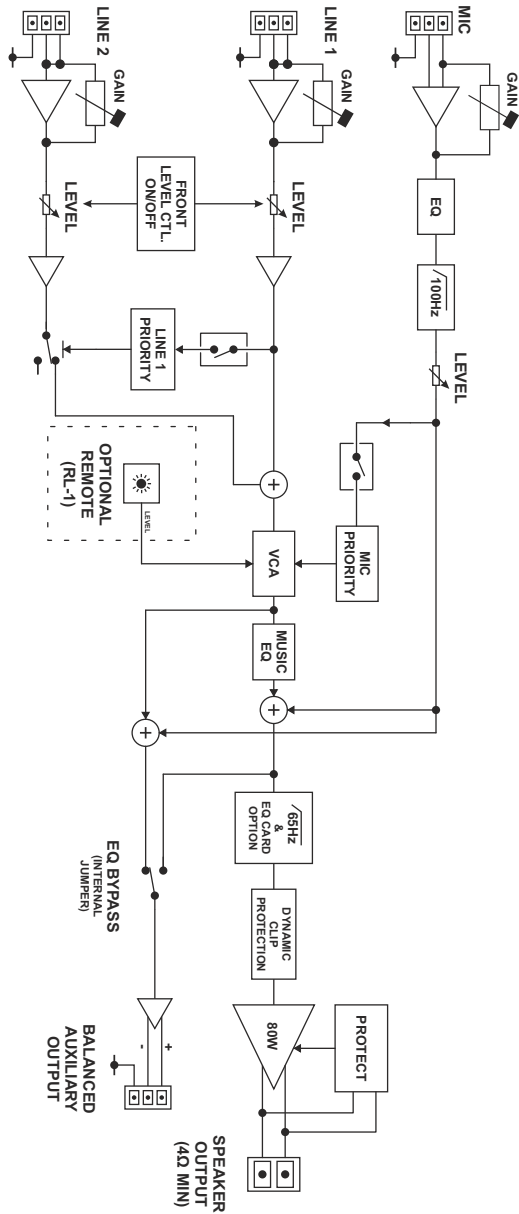

# FRONT PANEL DESCRIPTION

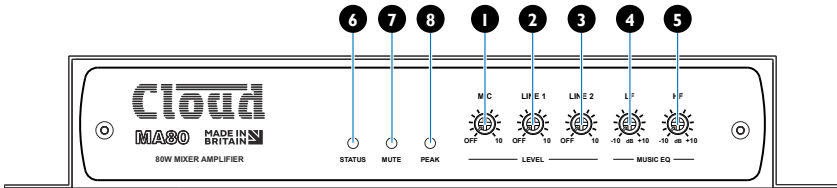

## LEVEL controls:

1. **MIC** – adjusts volume of the signal connected to the **MIC** input.
2. **LINE 1**– adjusts volume of the signal connected to the **LINE 1** input.
3. **LINE 2** – adjusts volume of the signal connected to the **LINE 2** input.

## MUSIC EQ controls:

4. **LF** – LF EQ adjustment of music channel: +/- 10 dB @ 50 Hz
5. **HF** – HF EQ adjustment of music channel: +/- 10 dB @ 10 kHz

## 6. **STATUS** – bi-colour LED: illuminates as follows:

- steady green - active
- steady red – sleep (APD) mode
- flashing green – fault condition (over-temperature, speaker wiring error or over-current); power-cycle to clear
- flashing red – fault condition (DC protection triggered); power-cycle to clear

Please see the “Troubleshooting – STATUS LED indications” on page 32 section for a full description of the above modes.

7. **MUTE** – red LED: illuminates when the MUSIC MUTE function is active
8. **PEAK** – red LED: illuminates if the amplifier’s dynamic clip protection becomes active

# REAR PANEL DESCRIPTION

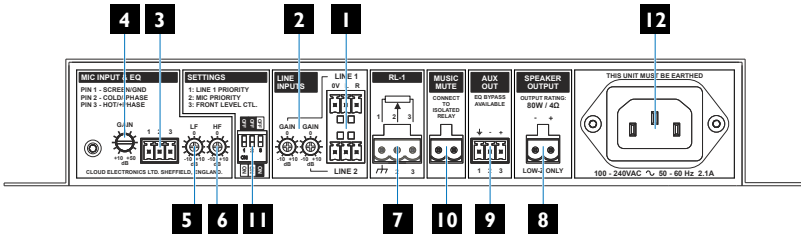

1. **LINE 1** and **LINE 2** – stereo line inputs for music sources (unbalanced).
2. **GAIN** – preset gain trim controls (+/-10 dB) for each line input.
3. **MIC INPUT** – balanced mic input.
4. **GAIN** – preset gain control for mic input; range +10 to +50 dB.
5. **LF** – LF EQ adjustment of mic signal: +/-10 dB @ 100 Hz.
6. **HF** – HF EQ adjustment of mic signal: +/-10 dB @ 5 kHz.
7. **RL-1** – for connecting an RL-1 Series remote volume control plate.
8. **SPEAKER OUTPUT** – amplifier output for low-impedance circuits.
9. **AUX OUT** – balanced line level output from pre-amplifier stage; post-EQ by default, may be selected to pre-EQ by internal jumper.
10. **MUSIC MUTE** – connect to external N/O or N/C contacts for remote muting of music sources.
11. **SETTINGS** – three-pole DIP switch for setting various amplifier configurations:



SWITCH		FUNCTION
1	<b>LINE 1 PRIORITY</b>	Enables LINE 1-over-LINE 2 priority
2	<b>MIC PRIORITY</b>	Enables mic-over-music priority
3	<b>FRONT LEVEL CTL</b>	Disables front panel <b>LINE 1</b> & <b>LINE 2</b> level controls and allows full range of volume control via <b>RL-1</b> remote control port

See “Summary of rear panel DIP switch functions” on page 31 in the Appendix section for full details.

12. Power input – standard IEC receptacle for AC mains, voltage range 100 to 240 V, 50/60 Hz. May be replaced by the 20 mm Flexible Conduit Adaptor Kit (Warepart CA947034) for installations where it is desirable for the amplifier to be permanently connected to the mains supply.

## INSTALLATION

### Mechanical

The compact size and light weight of the MA80 combined with its high energy efficiency allows it to be installed in almost any location. It can be easily placed in ceiling or wall voids, or fitted to the rear of display screens or loudspeaker cabinets.

The amplifier has mounting flanges with keyhole slots to permit it to be secured on a horizontal or vertical flat surface.

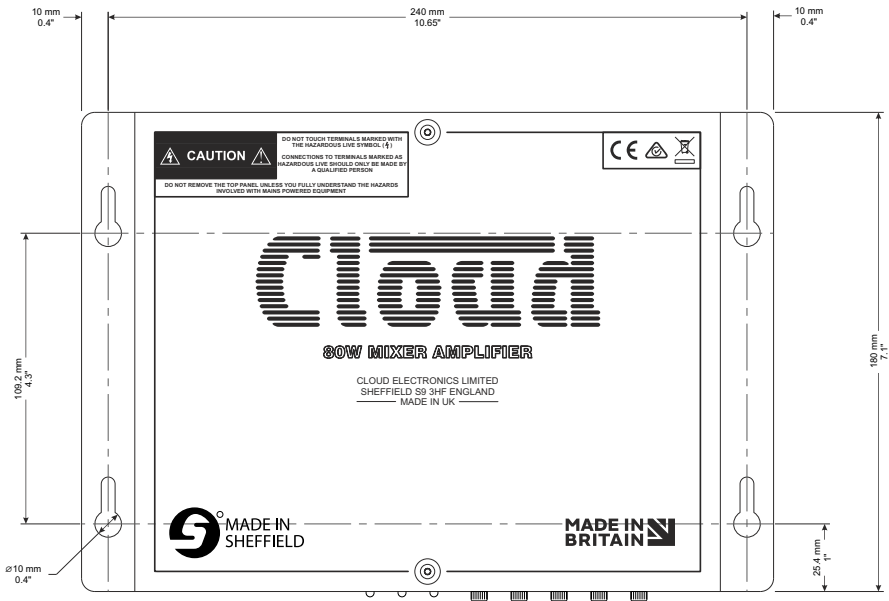

If using the MA80 in a free-standing situation, the self-adhesive feet (supplied with the amplifier) should be fitted. The amplifier should always be stood on a flat surface. Care should be exercised in selecting a location for a free-standing unit, which should allow ventilation but be clear of any liquid or similar hazard.

## Ventilation

The amplifier uses natural convection cooling, and care should be taken to locate it where airflow is unrestricted (e.g., not under ceiling insulation material). Consideration should also be given to ease of access, should the operational configuration or audio levels need adjustment after installation.

In free-standing installations, always fit the rubber feet supplied, and do not stand any other items on top of the unit.

## Connections and adjustments

### Line inputs

The amplifier has two stereo line inputs **1**, each of which is mixed internally to mono; these inputs are suitable for most music sources such as computer line outputs, satellite receivers, CD/DVD players and the like.

The inputs are unbalanced and use 3-pin 3.5 mm-pitch screw terminal connectors. The connectors should be wired as follows:

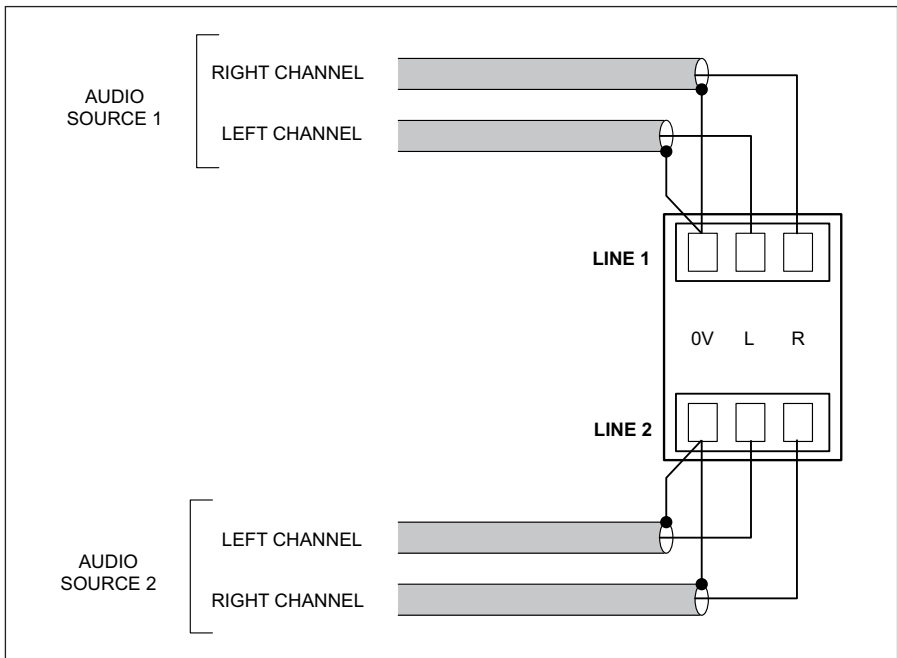

The two line inputs are summed together internally: however, note that Line input 1 can be configured to have priority over Line input 2, see “Line 1 Priority” on page 21.

## Sensitivity & Gain Control

Each of the stereo line inputs has an input impedance of 10 kohms and a preset type gain control on the rear panel adjacent to the input sockets **2**. The gain controls have a range of 20 dB allowing the input sensitivity to be varied from -12 dBu to +8 dBu (0 dBu = 0.775 V<sub>rms</sub>). The gain controls should be set so that the input sources in use do not distort, and the front panel level controls **2** and **3** have a useful range.

## Music Level and EQ control

The front panel **LINE 1** and **LINE 2** controls **2** and **3** should be adjusted during installation to set the volume of the audio sources. The line inputs are summed post the level controls (thereafter referred to as the "music channel"); equalisation can be applied using the front panel **LF** and **HF** controls **4** and **5**, which can apply a cut or boost of up to 10 dB at 50 Hz and 10 kHz respectively. Adjust the EQ controls to suit the audio programme material being used, the speaker characteristics and the room acoustics. If the programme material includes speech, the EQ should be adjusted for best intelligibility.

If the line input levels are set too high, the amplifier's dynamic protection will activate to prevent clipping and the front panel **PEAK LED** **8** will illuminate to indicate this. Note that this LED also indicates an excessive mic signal level.

## Line 1 Priority

When both line inputs are in use, one audio source can be given automatic priority over the other by connecting it to Line 1 input and setting rear panel **SETTINGS** DIP switch 1 (**LINE 1 PRIORITY**) to ON. This is a useful facility when a Digital Sound Store, jukebox, emergency announcement system or similar source forms part of the audio system.

When Line 1 Priority is enabled, the amplifier will route the input signal at Line 2 normally until a signal is detected at Line 1's input. When this happens, the music source automatically switches to Line 1 only. Once the signal at Line 1 stops (e.g., when an announcement finishes), the source connected to Line 2 will smoothly restore to its former level over approx. 3 seconds.

## Mic input

The MA80 has a single microphone channel, enabling it to be used for announcements, commentary, karaoke or any other purpose requiring a microphone. By default, the mic channel is independent and is simply mixed with the summed line inputs, but may be reconfigured so that it has automatic mic-over-line priority. See “Microphone priority” on page 23 for more details.

The mic input **3** is a 3-pin 3.5 mm-pitch screw terminal connector. Use the wiring shown below.

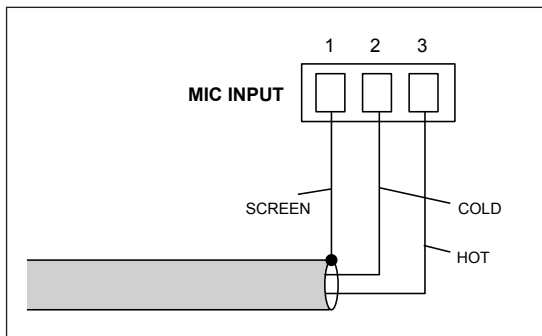

The MA80’s microphone pre-amplifier is an electronically balanced, transformerless design configured for optimum low noise performance. The input impedance is greater than 2 kohms and is suitable for microphones in the 200 ohm to 600 ohm range. The microphone signal path includes a fixed high-pass filter. This attenuates the response below 100 Hz, which helps to reduce the effects of microphone handling noise.

12 V phantom power is available at the mic input, and is activated by setting internal jumper J6 to the ON position. See “PCB layout diagram” on page 29 for further information regarding the internal jumpers. Care should be taken to ensure that phantom power is enabled only when the microphone in use requires it – i.e., a capacitor or electret type: other types of microphones (such as dynamic) may be damaged if a DC voltage is applied to them.

## Mic gain adjustment

The mic input has a preset gain control **4** adjacent to the input connector. The gain can be adjusted over a range of 40 dB, from 10 dB to 50 dB.

## Mic level control

A front panel level control **1** is provided for the mic channel and this provides the user with a means of adjusting the volume of the microphone. The rear panel gain control **4** should be set at a level where distortion does not occur even when the front panel level control is fully clockwise. If the mic level is set too high, the front-panel **PEAK LED 8** will illuminate. Note that this LED also indicates excessive music level.

## Mic EQ

The mic input has associated LF **5** and HF **6** EQ controls. These provide 10 dB of cut or boost at 100 Hz and 5 kHz respectively and should be adjusted by listening, to achieve a clear mic sound. The purpose for which the mic input will be used should be borne in mind when making adjustments.

## Microphone priority

By default, the microphone channel is simply mixed with the music channel. It may be reconfigured with **SETTINGS** DIP switch 2 to have automatic priority over the music channel.

With **SETTINGS** DIP switch 2 – **MIC PRIORITY** - set to ON, a signal at the mic input will automatically mute both line inputs; typically this configuration should be selected to give announcements or commentary priority over background music. When the announcement is complete, the music channel fades back up to its previous level.

When ON, mic-over-line priority also has priority over Line 1 priority, meaning that a microphone announcement will always be heard, even if a Line 1 input is currently causing Line 2 to be muted.

## Speaker Output

The power amplifier stage is fully protected against DC offset, PSU and amplifier over-current, and is also thermally protected. Activation of the protection circuitry shuts the power amplifier stage down until the fault condition clears. All protection conditions will automatically self-clear if the amplifier is power-cycled. A switch-on delay function mutes the output during power-up and power-down to protect loudspeakers.

The MA80 can deliver its rated power of 80 W into a 4 ohm load. When using multiple low-impedance loudspeakers (generally 8 ohms) with a single amplifier, series and parallel wiring should be employed to produce a total load impedance of not less than 4 ohms.

The low impedance output is available at the 2-pin 5 mm-pitch screw terminal **SPEAKER OUTPUT** connector on the rear panel **8**.

If driving 100/70/25 V line loudspeaker systems, a suitable external transformer must be connected between the amplifier output and the loudspeakers. With such systems, there is a risk of transformer core saturation at high levels and low frequencies, which can produce distortion. To prevent this, the MA80's output stage is provided with a switchable 65 Hz high-pass filter. We recommend that the filter is always enabled when the amplifier is used with 100/75/25 V line systems.

The filter is enabled/disabled by moving internal PCB jumper J3. See "PCB layout diagram" on page 29 for locations of PCB jumpers.

## Auxiliary Output

The amplifier is provided with an Auxiliary Output, **AUX OUT 9**. This may be used to drive an additional amplifier, for recording, or any other purpose where system "expansion" is required. The connector is a 3-pin, 3.5 mm-pitch screw terminal type.

The signal at the Auxiliary Output is balanced and at line level, and can thus be used to drive most external equipment directly. The connector pinout is identical to that used for the amplifier inputs:



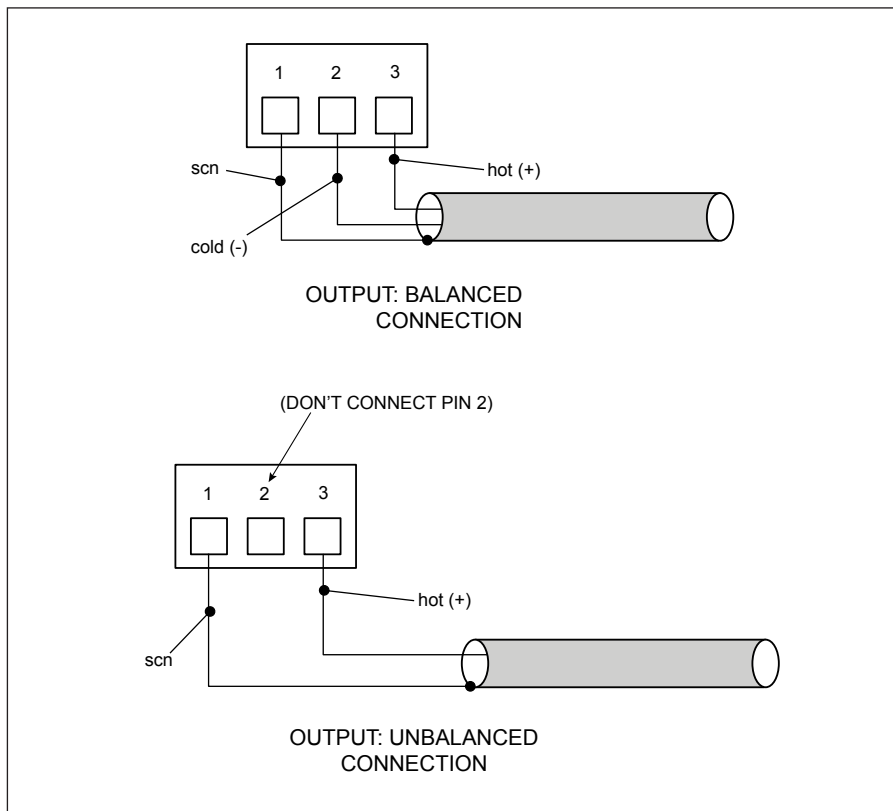

The “out-of-the-box” factory default source for the Auxiliary Output is taken from the input to the power amplifier stage, and will thus consist of the same mix of line and mic inputs, and will be affected by both Line 1 and Mic Priorities. However, it will not be subject to the action of either the 65 Hz high-pass filter nor any optional EQ cards which may be fitted.

This means that by default the source is derived “post” the front panel MUSIC EQ controls. In some installations, it may be desirable to ensure that the EQ controls only affect the output to the loudspeakers connected to the amplifier’s main output and not the Auxiliary Output as well. This can be achieved by moving internal PCB jumper J7 from ROOM (post-EQ) to FLAT (pre-EQ). See “PCB layout diagram” on page 29 for details of PCB jumper locations.

## Remote Control

The MA80 amplifier is provided with a rear panel **RL-1** connector **7**, which may be used to remotely control the volume of the music channel. The usual method of doing this will be by connecting a Cloud RL-1 Series remote volume control plate, but music volume may also be controlled by an externally applied DC voltage (0 to 10 V), permitting volume adjustment by external control systems.

The **RL-1** connector is always enabled, but in many situations it will be desirable to disable the front panel **LINE 1** and **LINE 2** controls so that the remote control plate is the sole means of adjusting music volume. This is achieved by the setting the DIP switch 3 **FRONT LEVEL CTL** to OFF (up).

Alternatively, if the DIP switch is left at its default setting of ON (down), the front panel controls will remain operational and may be used to set the maximum level at the output. The remote control plate will adjust the volume only within this range, from zero to the maximum level set by the front panel controls.

**IMPORTANT:** Please note that this method of **RL-1** operation differs slightly from that used in other Cloud products.

### Connecting an RL-1 Series remote control plate

Connect an **RL-1** Series plate as shown below using twin-core screened cable. Maximum reliable cable run is 100 m. Set DIP switch 3 as required, as described above.

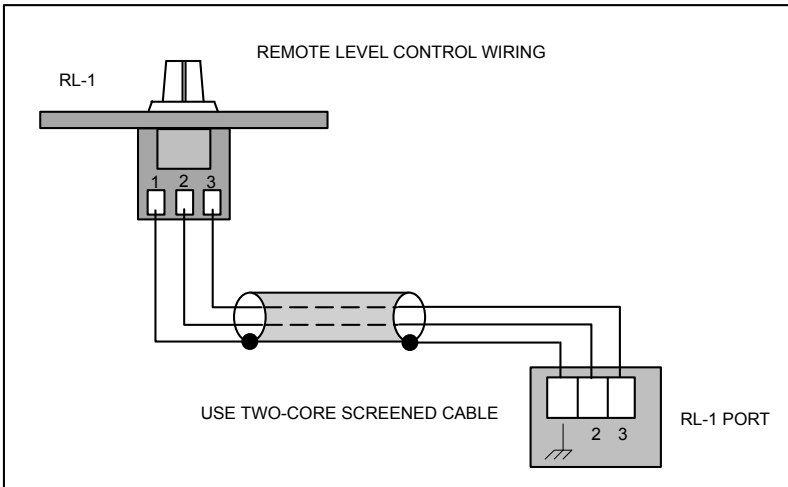

## Control of music level via external DC

It may be necessary in some installations to adjust the music level from an external control system (e.g., Crestron, AMX, etc.). If the RL-1 connector is not required for an RL-1 Series plate, it may be used to receive DC voltages from the external system to effect these adjustments.

Music level may be varied over its full range by applying a DC voltage of between 0 and +10 V to pin 2 of the RL-1 connector, with the 0 V reference connected to pin 1 (indicated by a 'chassis' symbol on the rear panel). 0 V on pin 2 corresponds to maximum level and +10 V will produce 90 dB of attenuation. The rate of attenuation is approximately 165 mV/dB.

## Music Mute Input

External muting of music may be commanded through the **MUSIC MUTE** connector **10**. National or Local Authority regulations governing installed audio systems may require that normal programme material (i.e., music) should be muted in an emergency, to ensure that any evacuation messages are clearly audible. When active, it mutes both line inputs, leaving the microphone input active.

The Music Mute input is on a 2-pin 5 mm-pitch screw-terminal connector. It should be connected to the appropriate alarm output on whichever building management system registers the alarm (typically the Fire System). The alarm output must be volt-free; if no such output is available, an intermediate relay or other isolation device must be installed between the alarm output and the Music Mute input.

The Music Mute input can be set to operate on either normally open (N/O) or normally closed (N/C) contacts via internal jumper J1 (see "PCB layout diagram" on page 29). The factory default setting is N/O, thus requiring a short-circuit to be applied across the two pins of the connector for muting to occur.

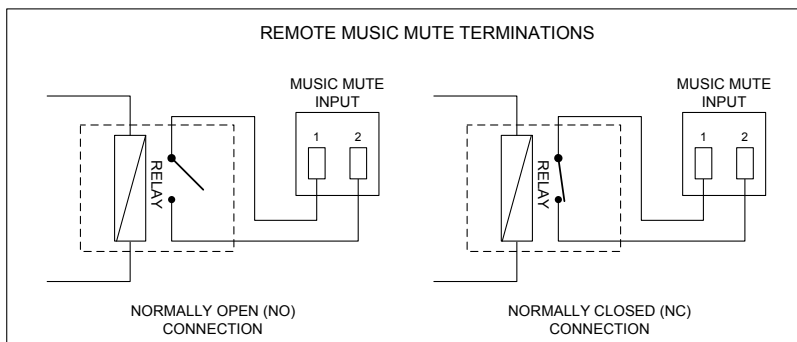

## Auto Power Down

The MA80 is an extremely energy-efficient amplifier, but can be made even more so by enabling the Auto Power-Down feature. When active, the signal level is constantly monitored and if no input signals are measured for 15 minutes the amplifier enters a “Sleep” mode, minimising power consumption. If an input signal is detected while the channel is in this mode, the amplifier “wakes up” in less than 450 ms: if the signal is a line input, the volume will be faded up over a period of three seconds.

The MA80 is shipped with the Auto Power Down function disabled. It may be enabled by moving internal PCB jumper J5. See “PCB layout diagram” on page 29 for details of PCB jumper locations.

## Loudspeaker EQ cards

The MA80 may be fitted with a single channel loudspeaker equalisation module. EQ modules are available from Cloud Electronics to suit several popular ranges of installed sound loudspeakers; please check current module availability at [www.cloud.co.uk/accessories](http://www.cloud.co.uk/accessories).

## Installation Instructions

Refer to the PCB layout diagram (see “PCB layout diagram” on page 29) for the location of the EQ module connector and its associated bypass jumper J2.

1. To install an EQ module, proceed as follows:
2. Isolate the amplifier from its AC power source\*.
3. Remove the screws securing the top cover: there are two on the top and two on each side. Remove the cover.
4. Remove jumper J2. We recommend “stowing” it on one of the header pins in case it ever needs to be replaced.
5. Plug the loudspeaker equalisation module into its 12-pin connector CON1; note that the connector has two notches on one side which engage with lugs on the module’s mating connector to ensure correct orientation.
6. Replace the top cover.

# APPENDIX

## PCB layout diagram

To access the internal PCB, disconnect the amplifier from its AC power source\* and remove the six screws securing the top cover; remove the cover.

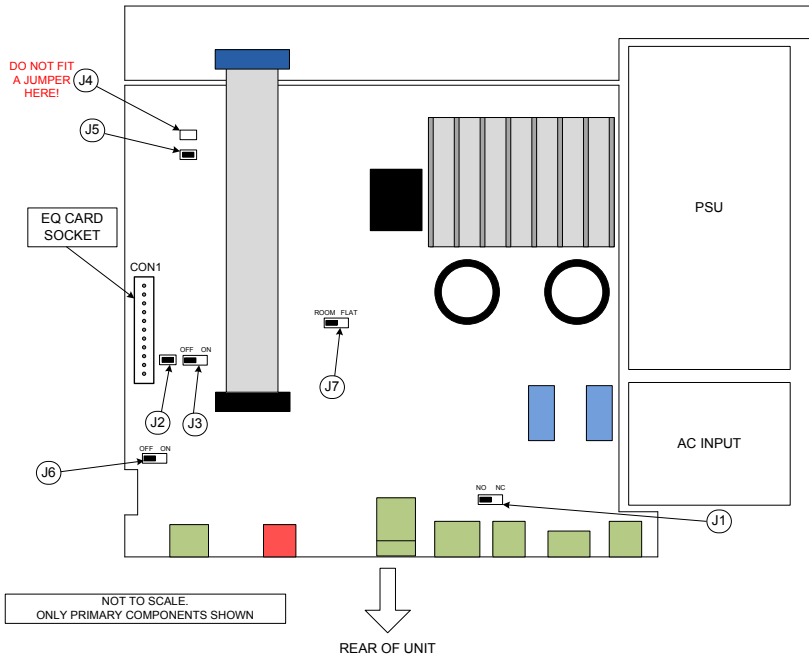

\*Note that if the optional conduit adaptor plate has been fitted, replacing the IEC receptacle, this may necessitate isolating the mains circuit to which the amplifier is connected.

## Table of internal jumpers and default settings

JUMPER	PURPOSE	OPTIONS	DEFAULT
J1	Music Mute	N/O or N/C	N/O
J2	EQ card bypass	Present: No EQ card Absent: EQ card fitted	Present
J3	65 Hz hi-pass filter	ON/OFF	OFF
J4	For factory use only – do not fit a jumper here		Absent
J5	Auto Power Down	Present: APD disabled Absent: APD enabled	Present
J6	+12 V Mic phantom power	ON/OFF	OFF
J7	Auxiliary output source	ROOM: source is post-front panel EQ FLAT: Source is pre-front panel EQ	Room

## Summary of rear panel DIP switch functions

DIP SWITCH		POSITION	FUNCTION
1	LINE 1 PRIORITY	<b>OFF = PRIORITY OFF</b>	The signals at LINE 1 and LINE 2 are always mixed together.
		ON = PRIORITY ON	A signal at LINE 1 input has priority over that at LINE 2: LINE 2 will be muted automatically.
2	MIC PRIORITY	<b>OFF = PRIORITY OFF</b>	The mic signal is mixed with the line inputs according to the front panel LEVEL controls.
		ON = PRIORITY ON	The mic signal will take priority over the line inputs, which will be muted while the mic is in use.
3	FRONT LEVEL CTL.	OFF = RL-1 ONLY	The summed line input level is only controlled by the level control on the remote control plate wired to the RL-1 connector. The two front panel LEVEL controls (LINE 1 and LINE 2) are disabled.
		<b>ON = LOCAL + RL-1</b>	LINE 1 and LINE 2 are mixed together and their summed level controlled by the remote control plate wired to the RL-1 connector in a range from zero to a maximum which is set by the front panel LINE 1 and LINE 2 controls.

Note: default settings are in **BOLD** text.

## Troubleshooting – STATUS LED indications

The MA80 is well protected against errors in speaker wiring and other inappropriate operating conditions. The speaker output is monitored for excessively low impedance (i.e., a short circuit) and for the presence of DC. The internal temperature of the amplifier's power stage is also monitored.

In the event of any of the pre-defined safety conditions being exceeded, the amplifier will enter Protection mode, and will cease passing audio. In this case, the cause of the problem should be investigated and resolved (see below) and the amplifier power-cycled to exit Protection mode.

The front panel **STATUS LED**  provides information about the amplifier's current state and will flash if Protection mode has been triggered.

INDICATION	STATUS	CAUSE
Steady green	Normal	No fault – normal operation
Steady red	APD Mode	Standby mode (if enabled)
Flashing green	Protection Mode	Over-temperature sensed or over-current protection triggered
Flashing red		DC detected at output terminals

### Fault resolution

#### **Over- temperature (STATUS LED flashes green):**

Check that the amplifier has sufficient airflow around the casing (e.g., it is not covered by ceiling insulation material or similar), and that the ambient temperature at the amplifier location is not above +40°C. Power-cycle the amplifier to cancel Protection mode.

#### **Over-current protection (STATUS LED flashes green):**

Over-current protection will be triggered if the load at the output terminals is less than 4 ohms; clearly this includes the possibility of a short-circuit. The amplifier needs to have an input signal and the level control(s) turned up for this protection to operate. Investigate the output wiring and check for a faulty loudspeaker. Power-cycle the amplifier to cancel Protection mode.

#### **DC protection (STATUS LED flashes red):**

DC protection will be triggered if one of the speaker terminals is shorted to ground. Check the loudspeaker wiring. It can also be triggered when the input signal contains high amplitude, low frequency components, such as may be caused by clicks and



pops from other connected equipment. Check the rear panel **GAIN** **2** and **4** and front panel **LEVEL** **1** to **3** controls are not set too high. It may be necessary to set the 65 Hz High Pass filter on (J3) to prevent false triggering. Power-cycle the amplifier to cancel Protection mode.

## EMC considerations

MA80 amplifiers fully conform to the relevant electromagnetic compatibility (EMC) standards and are technically well behaved. You should experience no problems interfacing units to other items of equipment and under normal circumstances, no special precautions need to be taken. If the unit is to be used in close proximity to potential sources of HF disturbance such as high power communication transmitters, radar stations and the like, it is suggested that input signal leads be kept as short as possible. Always use balanced interconnections wherever possible. We recommend that the MA80 amplifier is not located in close proximity to a high-power amplifier or similar item of equipment, which may radiate a strong magnetic field from its power transformer.

## Earthing

When several mains powered units are connected together via their signal cables, there is a risk of one or more earth loops which may cause an audible hum on the system even with the gain controls set to minimum. The 0 V rail of an MA80 amplifier is directly coupled to the chassis ground. No interconnection problems should be encountered, but if there is any hum or other extraneous noise when source equipment is connected, the situation can generally be remedied by observing the following guidelines:

- Always connect sources using balanced connections wherever possible. Note that, for EMC reasons, the cable screen should be connected at both ends.
- Use audio isolating transformers (readily available from trade suppliers) at the inputs if necessary. These will ensure that the amplifier is electrically isolated from the source equipment.
- The signal source units should be located as close as practical to the amplifier. The metal housings of the various units should not be electrically connected. Try to ensure that all interconnected units, including power amplifiers, are connected to a common power source to ensure a common ground is provided.

## Technical specifications

LINE INPUTS	
Frequency Response	+/-1 dB, 20 Hz to 20 kHz
THD+N	<0.05% (1 kHz, full power, 22 kHz bandwidth)
Sensitivity	-12 dBu (195 mV) to +8 dBu (2.0 V)
Input Gain Control	20 dB range
Input Impedance	47 kohms
Headroom	16 dB
Noise	<-95 dB
Music Equalisation	LF: +/-10 dB @ 50 Hz, HF: +/-10 dB @ 10 kHz
MICROPHONE INPUT	
Frequency Response	-3 dB @ 100 Hz (filter) to 20 kHz +/-1 dB
THD+N	<0.05% (1 kHz, full power, 22 kHz bandwidth)
Gain	10 dB to 50 dB
Input Impedance	2.7 kohms (balanced)
Headroom	16 dB
Noise	EIN: -127 dB (22 kHz bandwidth, $R_s = 150$ ohms)
Phantom Power	+12 V (internal jumper)
Mic Equalisation	LF: +/-12 dB @ 100 Hz, HF: +/-12 dB @ 5 kHz
MAIN OUTPUT	
Output Power (1 kHz continuous sine wave)	80 W into 4 ohms, 1 kHz continuous sine wave
High Pass Filter	-3 dB @ 65 Hz (selectable by internal jumper)
AUXILIARY OUTPUT	
Max output level	0 dBu (0.775 $V_{rms}$ )

GENERAL		
Power Supply (internal)	Universal type, 100 V to 240 V, 50 to 60 Hz	
Power consumption	Standby <sup>1</sup>	0.88 W, 7.35 VA
	Idle <sup>2</sup>	5.41 W, 13.39 VA
	1/8 <sup>th</sup> Power (4 ohms) <sup>3</sup>	17.4 W, 31.75 VA
	1/3 <sup>rd</sup> Power (4 ohms) <sup>4</sup>	30.4 W, 50.58 VA
Heat Loss	Standby <sup>1</sup>	3.2 KJ/hr (3.0 BTU/hr)
	Idle <sup>2</sup>	19.5 KJ/hr (18.5 BTU/hr)
	1/8 <sup>th</sup> Power (4 ohms) <sup>3</sup>	26.3 KJ/hr (24.9 BTU/hr)
	1/3 <sup>rd</sup> Power (4 ohms) <sup>4</sup>	27.0 KJ/hr (25.6 BTU/hr)
Amplifier protection	Fixed level signal limiter Protection against DC, PSU overcurrent, amplifier overcurrent, over-temperature. Resettable internal breaker (no fuses)	
Cooling	Natural convection	
Dimensions (w x h x d)	Net	260 mm x 41 mm x 180 mm 10.24" x 1.61" x 7.09"
	Shipping	400 mm x 145 mm x 255 mm 15.75" x 5.71" x 10.0"
Weight	Net	1.35 kg
	Shipping	2.05 kg

Notes re Power Consumption and Heat Loss measurements:

All measurements at 230 VAC 50 Hz power input

1. Standby: amplifier in standby state (STATUS LED steady red)
2. Idle: amplifier not in standby state (STATUS LED steady green), but no audio output
3. 1/8<sup>th</sup>. Power: constant sound level at 10 W output (audio mainly clean, only occasional clipping)
4. 1/3<sup>rd</sup>. Power: constant sound level at 27 W output (audio beginning to become compressed, limited or heavily clipped)

[www.cloud.co.uk](http://www.cloud.co.uk)

**cloud**

[www.cloudusa.pro](http://www.cloudusa.pro)

**MADE IN BRITAIN** 